

## PMCG II - MANUAL

### PMCG ORIGINAL INSTRUCTIONS

Manufactured: Preservatech Europe sp z o.o.  
Równa 1, 85-846 Bydgoszcz, Poland  
info@preservatech.eu

Designed: Preservatech Inc  
Toronto, Canada  
info@preservatech.com

## Contents

<b>INSTALLATION .....</b>	<b>3</b>
<i>PACKING LIST.....</i>	<i>4</i>
<i>INSTALLATION RECOMMENDATION .....</i>	<i>5</i>
<i>CONNECTION OF AIR HOSES TO THE CASE .....</i>	<i>5</i>
<i>SENSOR CONNECTION .....</i>	<i>6</i>
<i>VENTILATION.....</i>	<i>6</i>
<i>WiFi ANTENNA .....</i>	<i>6</i>
<i>EXTERNAL CONNECTION.....</i>	<i>6</i>
<b>OPERATION MANUAL.....</b>	<b>7</b>
<i>TOUCH SCREEN DISPLAY.....</i>	<i>7</i>
<i>PROGRAMMING.....</i>	<i>8</i>
<i>NETWORK CONFIGURATION.....</i>	<i>9</i>
<i>MASTER – SLAVE CONFIGURATION.....</i>	<i>10</i>
<i>SETTING MACHINE TO USE AS MASTER/SLAVE SET .....</i>	<i>10</i>
<i>SLAVE MACHINE .....</i>	<i>10</i>
<i>MASTER MACHINE.....</i>	<i>10</i>
<i>MASTER/SLAVE CONFIGURATION SAMPLE.....</i>	<i>11</i>
<i>USING DATA LOGGER .....</i>	<i>12</i>
<b>SHIPPING AND STORAGE.....</b>	<b>12</b>
<b>LIMITED MICROCLIMATE GENERATOR WARRANTY.....</b>	<b>13</b>
<b>DECLARATION OF CONFORMITY .....</b>	<b>14</b>

### INSTALLATION



The PMCG generator is a miniature humidity control device for museum showcases and similar small sealed enclosures. This unit can reliably control humidity for individual well sealed enclosures.

When properly installed, this microclimate control system will typically maintain the relative humidity level in a sealed enclosure within two percent (or less) of an operator determined value.

Depending upon the ambient temperature conditions and enclosure construction, relative humidity levels of less than twenty to over sixty percent can be attained.

This unit will work only with high quality display cases with an air change rate of 0.2 per day or better.

This manual will assist you in installing and setting up the unit, as well it contains complete instructions on operating the unit.

PMCG units are supplied in two physical configurations (vertical and horizontal connections) and two humidity modes (DD-dehumidifying only, DH- dehumidifying and humidifying)





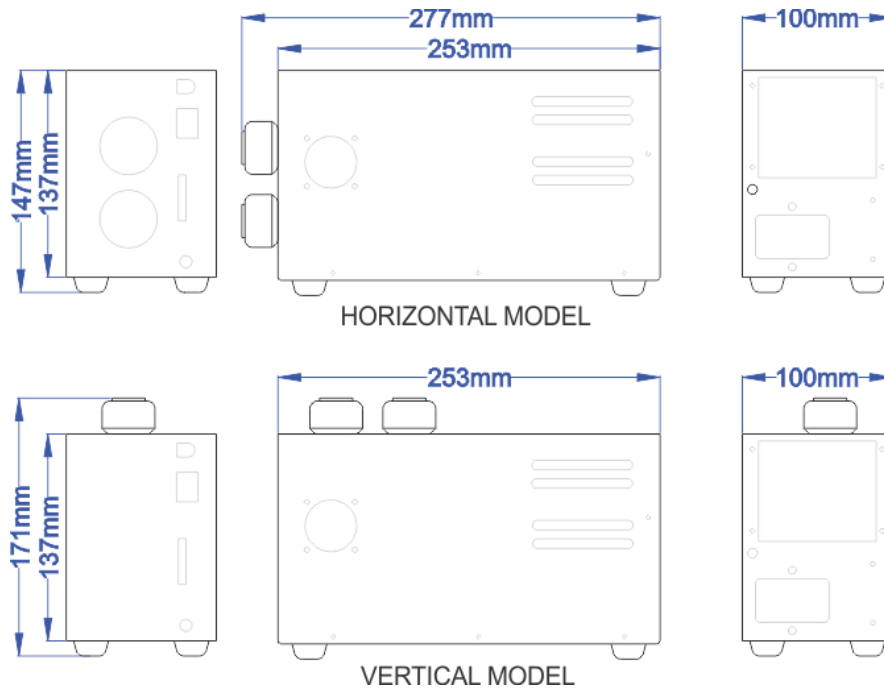

Proper installation of this unit is critical to achieve the best possible performance. Please carefully read the following chapters before installation.

## PMCG II - MANUAL

### PACKING LIST



Standard package consists of:

PMCG unit (1 pc)		Power cord (1 pc)	
22 mm silicone hose for air distribution (2m)		air connector (2 pcs)	
RH/T sensor (1 pc)		WiFi Antenna	

Optional parts (to be ordered separately)

- Alarm cables with LED
- Additional Silicone hose.
- SD Card for data logger
- Extension cord for WiFi antenna
- Booster fan.

## PMCG II - MANUAL

### INSTALLATION RECOMMENDATION

Before installation it should be determined how the machine will be connected to the case. The layout of the hoses leading to the case can make a large impact on the performance of the unit.

- The Machine output hose should be as short and straight as possible. The PMCG is produced in two arrangements: vertical and horizontal. Choose the best version for your application.
- The Machine input hose should be as short as possible, if possible avoid bends in the hose or the use of elbows or fitting.
- Using any kind of elbows/fittings or bends in the machine hoses can significantly reduce the PMCG's performance.
- RHT sensor, for best results should be installed inside the case, around air inputs from the machine. (do not install directly in the path of flowing air)

### CONNECTION OF AIR HOSES TO THE CASE

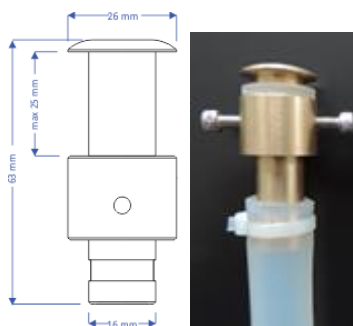
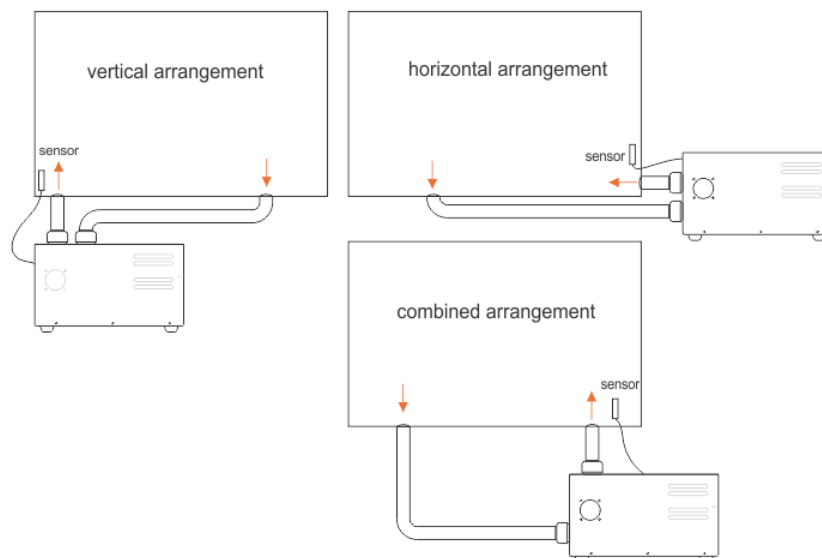

Typically, the PMCG is supplied with a silicone hose with an inner diameter of 5/8" - 16 mm. Connect to the hose using the fittings installed by the case manufacturer or with Preservatech's supplied air connectors (brass). For factory installed fittings we suggest a welded piece of metal pipe, 16 mm outer diameter and 30-40 mm long. For installing our brass fittings, a hole of 16 to 20 mm in diameter must be drilled in the case wall with a maximum wall thickness 1" - 26mm.

**THE AIR FROM THE PMCG SHOULD ENTER DIRECTLY INTO THE VITRINE FOR OPTIMAL PERFORMANCE. AIR DIRECTED INTO THE SUB FLOOR MAY LIMIT THE PERFORMANCE OF THE PMCG, ESPECIALLY IN LARGER OR LEAKY ENCLOSURES. TAKE CARE TO SEPARATE THE AIR ENTRY AND AIR RETURN PORTS AS FAR AS POSSIBLE. AVOID THE "SHORT CIRCUITING" OF AIR FLOW, ESPECIALLY WHEN PORTS ARE LOCATED UNDER A FLOOR PLATE.**

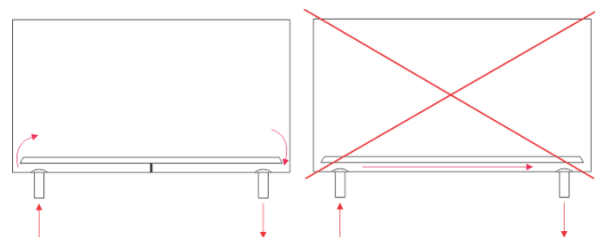

## PMCG II - MANUAL

### SENSOR CONNECTION



The sensor supplied with the PMCG is built inside a brass housing 9/32" / 7mm in diameter and has a 1.8 m long cable.

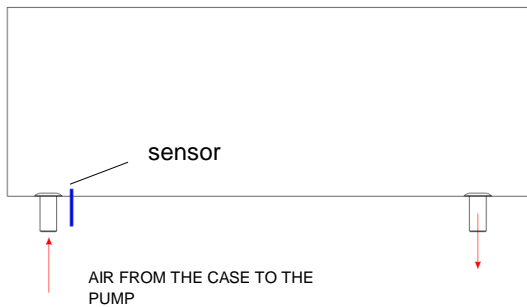

In most applications, locate the sensor near (but not directly in) the air input from the PMCG.

Where enclosure volumes are larger, or where showcase leakage is suspected, the sensor may be located close to the artefacts on display. Note that this may result in more variance with the target settings.

### VENTILATION

The PMCG generates very little heat so there is no need for special ventilation arrangements to disperse heat. However, if the PMCG is located in an enclosed space it will change the humidity in the surrounding area. For maximum performance, it is recommended that the enclosure that holds the PMCG is not completely sealed off from the outside. In most instances, natural cracks/spaces in the display cases utility space will be sufficient for the proper operation of the PMCG. If the utility space of the case is well sealed we recommend installing a small vent or leaving a few millimetres of space between the enclosure panels.

### WiFi ANTENNA



The WiFi Antenna needs to be installed only if Preservatech's monitoring service is in use. If the machine is located inside a metal enclosure (eg. Under the case made of steel) it is highly possible that the WiFi connection will be poor or non-existent. In this situation, the antenna needs to be installed outside of the metal enclosure. A Wifi antenna extension cord can be supplied by Preservatech. (Antenna is included in a standard order; extension cord is an additional option)



### EXTERNAL CONNECTION

The PMCG is equipped with a external connector for OUT OF RANGE alarm. This alarm is a 12 VDC connector to power up an LED or other 12VDC device. This alarm is activated when the RH at the sensor is lower or higher then SET VALUE  $\pm$  "Rh error offset" parameter (see Programming) EXTERNAL ALARM CONNECTOR IS LOCATED ON THE BACK WALL IN THE RIGHT BOTTOM CORNER.



**NOTE:** Although all PMCG machines are equipped with external receptacle, cables and LED's are not included in the standard shipment. It must be ordered separately.

## PMCG II - MANUAL

### OPERATION MANUAL

#### TOUCH SCREEN DISPLAY

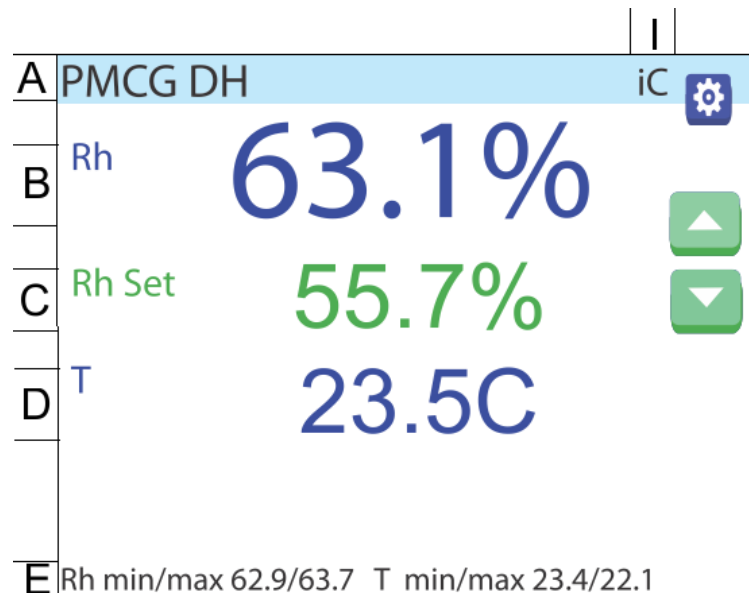

The touch screen is divided into a few areas with different functions. Below is an explanation of all the display areas.

**The display will turn off after 10 minutes of being idle. Lightly tap the display to turn it back on.**

A	Humidity generator model (PMCG DH or DD)
B	Relative humidity measured by the machine's sensor (inside the display case) Under normal conditions, the digits are blue, when measured RH is out of range, digits change to RED and start BLINKING. OUT OF RANGE STATUS IS DETERMINED BY PARAMETER "RH error offset" (see "Programming Chapter")
C	Target RH. Can be adjusted by arrows on the right (G and H)
D	Temperature measured by the machine's sensor (inside the display case)
E	Displays the minimum and maximum values for RH and T in the last 24 hours.
F	Button for programming mode. See chapter: Programming.
G & H	Arrows to change target RH value. Use G to raise target RH, H to lower target RH.
I	Shows status of WiFi connection. i = Wi-Fi initialized C = Connected to server



# PMCG II - MANUAL

## PROGRAMMING



**Back** 0.0.29.0 After pushing the “Programming Button” (F) display will change to programming mode. 



External T 23.4  The display will show a list of parameters with some that can be changed by the user. Use the slider on the right side of the display to go to the next parameter.

External Rh 63.1  Parameters which can be changed have a small button on the right side of the value.

Rh preset 55.7  After pressing it, the display allows to change this parameter. 

Rh error offset 10.0 

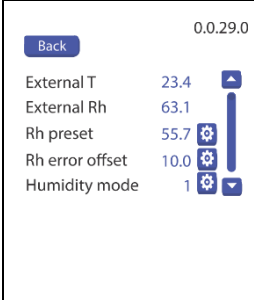
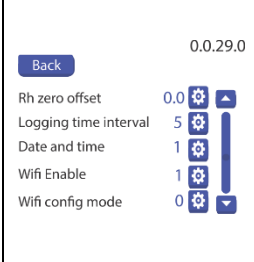
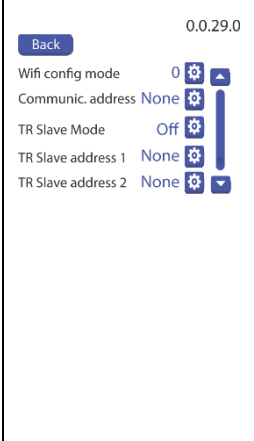
Humidity mode 1  





	External T	The temperature measured by sensor. Read only.
	External RH	The relative humidity measured by sensor. Read only.
	Rh preset	The target value of RH.
	Rh error offset.	Controls RH alarm. The RH alarm is activated when the measured RH is larger then the “rh preset” + “Rh error offset” or is lower then the “rh preset” - “Rh error offset”. Factory default=10
	Humidity Mode	Mode of PMCG. If visible, read only. DO NOT CHANGE THIS.
	Rh zero offset	Allows to offset measured RH value. Client can use it if the value on the machine display is different then on third party measuring device. Eg. If difference between measurements is 2%, setting this parameter to 2 will change display by 2.
	Logging time interval	Time span between logging data. In minutes.
	Date and time	Setting proper time and date.
	Wifi Enable	Enable WiFi service. 1=ON, 0=OFF
	Wifi config mode	Configures Wi-Fi network. See chapter Network Configuration.
	Communication address	Factory default:0 . It can be changed to allow communication between machines in master-slave mode. See chapter Master-Slave Configuration for more detailed information.
	TR Slave Mode	For setting a machine as a Slave. See chapter Master-Slave Configuration for more detailed explanation.
	TR Slave address	If a machine is set as a master, this parameter must correspond with the slave machine(s). Must be different then master machine communication address. See chapter Master-Slave Configuration for a more in depth explanation.
	Language	Choice between English and Chinese. This change only language of status display, not configuration language.
	Config	For Preservatech staff usage only. Access secured with password.



## PMCG II - MANUAL

### NETWORK CONFIGURATION

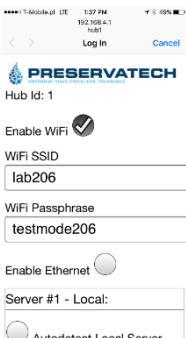
To use the rhmonitoring.com service, the machine must be set to work with the local Wi-Fi network. Two parameters must be known before setting up: Wi-Fi SSID (name of local WIFI network) and access password for this network. Setting can be done with any Wi-Fi enabled smartphone.

<p><b>Wifi config mode</b></p> <p><a href="#">Back</a></p> <p>Hub_11291479 Wifi SSID: "PRESERVATECH_EUROPE" Wifi Pass: "12345678" Server 1 IP: 0.0.0.0 Server 2 Name: "pws.iq.direct" Server 3 Name: ""</p>	<ol style="list-style-type: none"> <li>To enter Wi-Fi configuration mode, in normal display mode push configuration button. </li> <li>Make sure "WiFi enable" parameter is set to "1"</li> <li>Using the slider, find "Wifi config mode" and push the configuration button located on the right. <span style="float: right;">Wifi config mode 0 </span></li> <li>After entering this mode, the display shows among others Hub id, WiFi SSID (network name) and WiFi Pass. For the proper operation SSID and Pass must be set to access local WiFi network.</li> </ol> <p>Using your smartphone choose connection with Hubxxxxx . (Machine must be in Wifi config mode)</p> <ol style="list-style-type: none"> <li>After login a new page with the machine data will pop up. (may takes up to 30s)</li> </ol> <div style="text-align: center;">  </div> <ol style="list-style-type: none"> <li>Enter proper SSID (Name of local WiFi network) and a password.</li> <li>Save data by pressing "Save to Hub" button.</li> </ol> <div style="text-align: center; margin: 10px 0;">  </div> <ol style="list-style-type: none"> <li>The display should show actual parameters with the new data.</li> <li>Shut down the machine and after 30 sec. turn it on again.</li> <li>Assuming a rhmonitoring.com account is ordered and setup, machine will be visible in the monitoring service.</li> </ol>
---	---

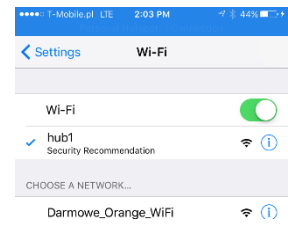

## PMCG II - MANUAL

### MASTER – SLAVE CONFIGURATION

If the case is large or leaky where one machine will not be sufficient, you can connect multiple machines in the Master/Slave mode.

Any standard machine can be set as master or slave with one master controlling up to 5 slaves. All slave machines mimic the operation of the Master machine. The master/slave group setup is comparable to using a larger machine with each machine connected directly to the case. The master/slave group can be connected directly into the case with each machine running its own air input or in a parallel sequence where the machines are connected together using tee connectors with one pair of hoses leading into the case. **We do not recommend using 1 master and multiple slaves for multiple show cases** since the output can vary between each machine.

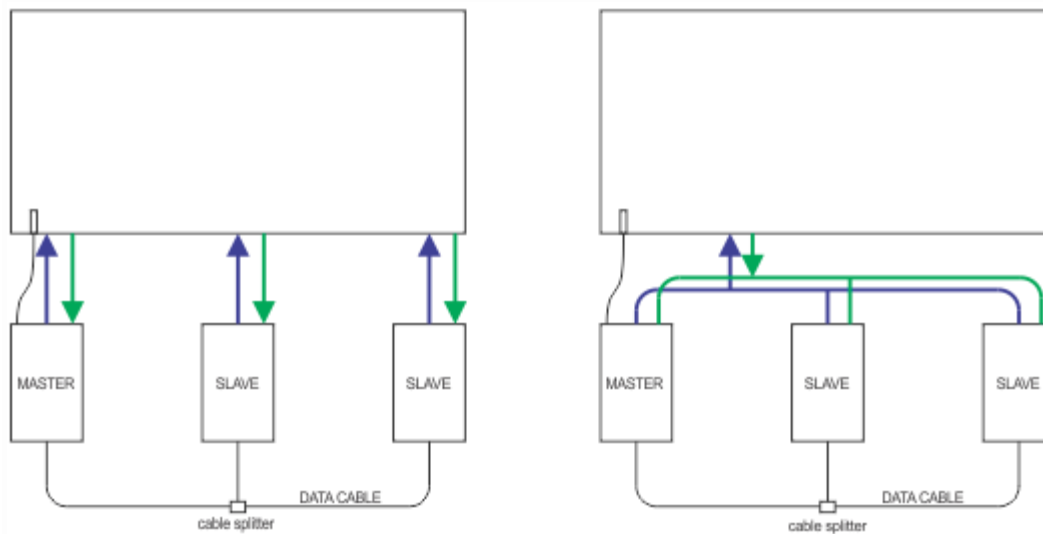

### SETTING MACHINE TO USE AS MASTER/SLAVE SET

Any machine can be set as a Master or Slave. To set a machine to work as a Master/Slave, a few parameters in the controller software must be changed.

All the machines need to be connected using a standard Ethernet cable. If more than one slave is in use, cable splitters need to be used. Network port is located on the back wall of the machine and is marked as "NETWORK".



**ONLY THE MASTER UNIT NEEDS A SENSOR CONNECTED.**

#### SLAVE MACHINE

The Slave unit will receive all readings from the Master unit and mimic the Master unit operation. Controller on the Slave unit will not work and display will show TrSlave on top of the display.





#### MASTER MACHINE

The only parameters to be set, are "TR Slave addresses". In this mode, all machines are controlled by master unit.

## PMCG II - MANUAL

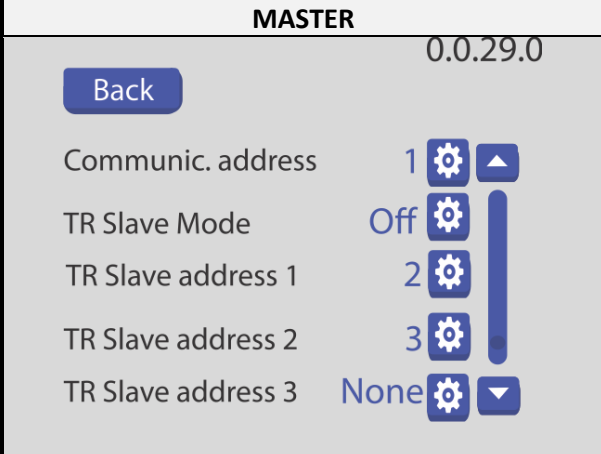
### MASTER/SLAVE CONFIGURATION SAMPLE

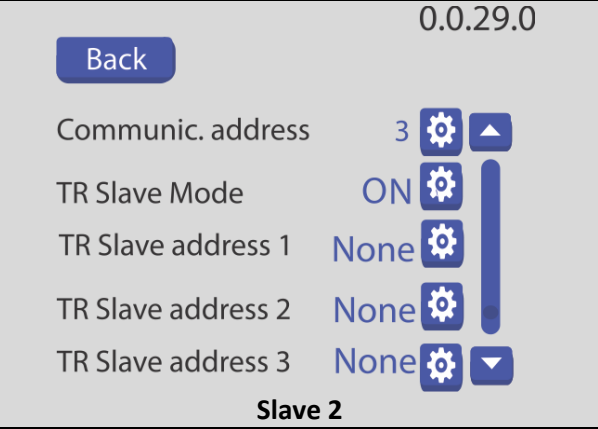
Below is a sample of setting up one master and two slaves machines.

MASTER		SLAVE	
			
Communication address	1	Communication address	2
TR Slave Mode	Off	TR Slave Mode	ON
TR Slave address 1	2		
TR Slave address 2	3		
TR Slave address 3,4,5	None		
		Communication address	3
		TR Slave Mode	ON
		Display of the slave machines will change. To go back to stand alone mode, press configuration button and change "TR Slave Mode to "OFF".	
		<div style="text-align: right;">TrSlave </div> <div style="text-align: right; background-color: #00aaff; color: white; padding: 2px;">LOW WATER</div>	

If more than 2 slaves are set, the master machine TR Slave address 3, 4, 5 must be set. The slave machines must be set accordingly to correspond with the master unit.

## PMCG II - MANUAL

### USING DATA LOGGER



The PMCG is equipped with a built-in data logger which logs RH levels measured by the machine inside the controlled display case. Slot for SD card is located on the back wall of the machine.

Time intervals can be changed between 1 and 60 minutes in 1 minute increments, please see "Programming" chapter.

Data written on the SD card, can be read in our free software or in any other software able to read CSV files (eg. Excell)

**IMPORTANT:** The SD Card used in our data loggers must be formatted as **FAT32** file systems. Other file systems are not compatible with our data loggers.

For the proper operation of the data logger, Date and Time as well as the time interval, must be set accordingly.

Please see "Programming" chapter for instructions how to set Time and Date.

### SHIPPING AND STORAGE

The PMCG should be stored in a clean area with temperature between 5°C – 30°C and relative humidity below 80%. All cables, hoses and attachments must be disconnected and machine should be placed within a clear plastic bag once properly dried.

If shipping is necessary, original packing is the best solution. Otherwise, machine must be shipped in a box properly cushioned with bubble foil, Styrofoam chips or other packing material preventing physical damage to the machine case.

### LIMITED MICROCLIMATE GENERATOR WARRANTY

This quality product is warranted to be free from manufacturer's defects in material and workmanship, provided that the unit is used under the normal operating conditions intended by the manufacturer, and in accordance with the Requirements for Proper Operation as outlined in this Installation and Operating Manual. This warranty is available only to the client to whom the unit was originally sold by authorized distributor of Preservatech Inc or Preservatech Europe s p z o.o., and is non-transferable.

#### TERMS OF WARRANTY

During the first two years, any electrical parts of this product found to be defective, including any sealed system units, will be repaired or replaced, at warrantor's option, at no charge to the ORIGINAL purchaser. To obtain service, contact Preservatech at the address below, who will provide you with instructions. Service must be performed by a qualified service technician, or with the express permission of Preservatech. If service is performed on the units by anyone other than an authorized service depot or agent, all obligations of Preservatech under this warranty shall be at an end.

#### EXCLUSIONS

Save as herein provided by Preservatech, there are no other warranties, conditions, representations or guarantees, express or implied, made or intended by Preservatech or its authorized distributors and all other warranties, conditions, representations or guarantees, including any warranties, conditions, representations or guarantees under any Sale of Goods Act or like legislation or statute is hereby expressly excluded. Save as herein provided, Preservatech shall not be responsible for any damages to persons or property, including the unit itself, howsoever caused or any consequential damages arising from the malfunction of the unit and by the purchase of the unit, the purchaser does hereby agree to indemnify and save harmless

Preservatech from any claim for damages to persons or property caused by the unit.

#### GENERAL PROVISIONS

No warranty or insurance herein contained or set out shall apply when damage or repair is caused by any of the following:

- 1) Damage in transit or when moving the appliance.
- 2) Improper power supply such as low voltage, power surges, defective wiring or inadequate fuses.
- 4) Accident, alteration, abuse or misuse of the appliance such as an inadequate supply of cooling air, or abnormal operating conditions.
- 5) Use of a unit that has been optimized for a particular application in another application that has not been approved by Preservatech
- 6) Fire, water damage, theft, war, riot, hostility, acts of God such as hurricanes, floods etc,
- 7) Service calls resulting in customer education.

#### WARRANTY SERVICE

Proof of purchase date will be required for warranty claims; so, please retain bills of sale. In the event warranty service is required, present a facsimile of the cover of this document to our AUTHORIZED SERVICE DEPOT. Please contact our head office for service instructions.

[info@preservatech.com](mailto:info@preservatech.com)

Declaration of Conformity

# CE DECLARATION OF CONFORMITY

**Product:** PMCG Humidity Generator

**Models:** PMCG – DH, PMCG-DD

**Description:** Constant humidity generator designed for controlling relative humidity inside a museum display cases.

**Manufacturer:** Preservatech Europe sp z o.o.

Rowna 1, 85-846 Bydgoszcz

**Country of origin:** Poland

The above mentioned product complies with following regulation:

EU Low Voltage Directive 2006/95/EC

EU Electromagnetic Compatibility Directive 2004/108/EC

Harmonised Standards: EN 60335-2-98:2003 + A2:2008, EN 61000-6-3:2007 + A1: 2011, EN 61000-6-1: 2007

Signed DEC 11, 2015 in Bydgoszcz



Jan Maternicki  
president