

FILTRATION SYSTEM SYSTEM CONFIGURATION

Mini One:

Filter case with 6mm barb on input and output. System is installed between Mini One air pump and Mini One unit. Any configuration of particle and carbon cartridges can be used.

PMCG:

Filter case with 22 mm quick connect input and fan unit with 22 mm quick connect output. System is installed between PMCG unit and the case. Configuration of any particle and canvas type cartridges can be used. GRANULATED CARBON CARTRIDGES CANNOT BE USED.

Stand Alone system:

Filter case with 6mm barb on input, air pump and 22mm quick connect output. System is shipped with proper silicone hoses and air fitting to connect hoses to the display case.

AIR PUMP FOR STAND ALONE UNITS

Air pump can be supplied in two versions: standard and with noise dampening cover.

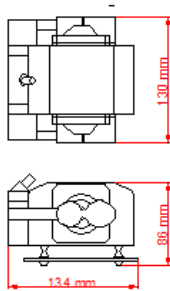

Standard Pump

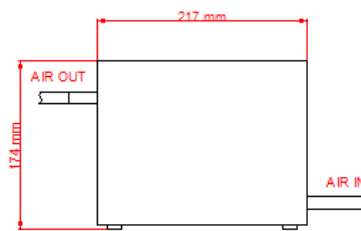

Pump with noise reducing cover

- Voltage: 110 or 220 V AC
- Power: 8W
- Weight: 1.5 kg
- Air flow: ~1500 l/h
- Noise:
 - o Standard Pump: 35dB (with hoses connected)
 - o With cover: < 22dB (with hoses connected)

ORDERING

FS	-	00	-	P0A	-		A0	-	B0
		Configuration		Air Pump			First cartridge - particle		Second cartridge
		01 PMCG		P0 No pump			A1 F7 type		B0 Standard Granulated Carbon
		02 Mini One		P1A Standard pump 110V			A2 H14 type		B1 Standard Canvas Carbon
		03 Stand Alone		P1B Standard pump 220V					B3 Non standard
				P2A Noise reduction 110V					
				P2B Noise reduction 220V					
				For PMCG and Mini One this must be "P0"					

Example: **FS-03-P2B-A2-B0** – Filter with connectors for Stand Alone unit, with Noise Reducing air pump 220V, H11 type particle cartridge and Standard Granulated Carbon cartridge.

CARTRIDGES



H11 – HEPA Filter

Size: 150 x 200 x 50 mm

Weight: 400g

Frame: galvanized Steel

Particle size bigger than 0.3 μ m, Virus [unattached], Carbon dust, Sea salt, All combustion smoke, Radon progeny.



F7 – MERV13 Filter

Size: 150 x 200 x 50 mm

Weight: 375g

Frame: galvanized Steel

Particle size within 0.3 μ m-1.0 μ m, All bacteria, cooking oil, Most smoke, Copier toner, Most face powders, Most paint pigments.

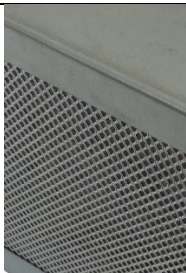

Granulated Carbon Filter

Size: 150 x 200 x 50 mm

Weight: 1000g (900g carbon)

Frame: galvanized Steel



Canvas Carbon Filter

Size: 150 x 200 x 50 mm

Weight: 270g

Frame: galvanized Steel



Non standard carbon filters.

- Coconut shell based, activated carbon impregnated with 0.01% metallic silver.
 - Non Standard Coconut shell based, activated carbon impregnated with 0.01% metallic bactericide.
 - Non Standard Coconut shell based, activated carbon impregnated with 0.01% metallic silver bactericide..
 - Non Standard Coconut shell based, activated carbon impregnated with 0.1% metallic silver.
-

-
- Non Standard Coconut shell based activated carbon impregnated with 0.05% metallic silver bactericide.
 -

For all non standard filters, minimum order (20) may be required.

CARTRIDGE INSTALLATION

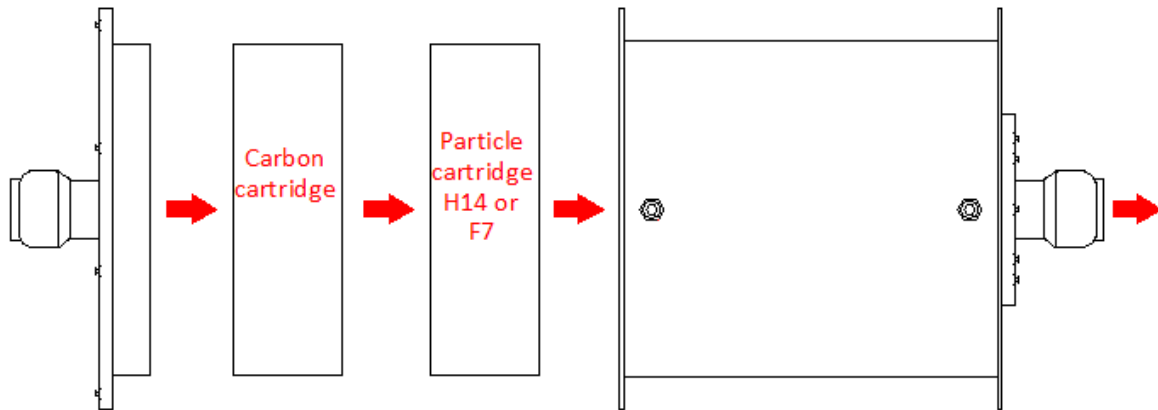





Filters are shipped with ordered cartridges already installed but when time comes for replacement it is important to do this in the correct order:

- First cartridge to install is the particle filter (H14 or F7) following the carbon cartridge. This configuration prevents any possible carbon dust from carbon cartridge to enter air stream.
- When installing the cover, it is important to make sure the silicone gasket is in the proper position to avoid leakage.

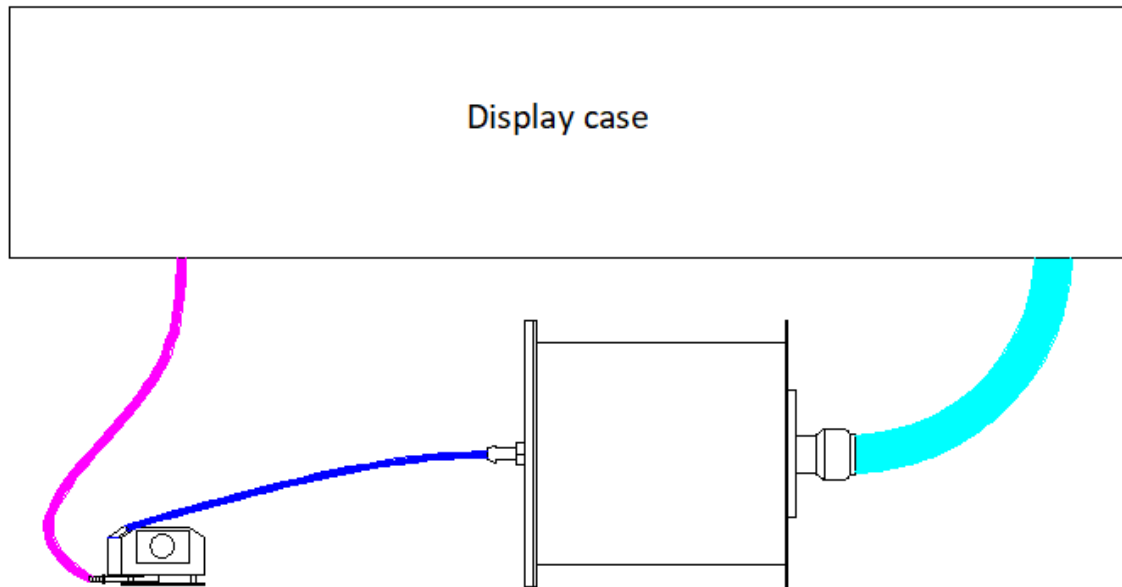
CONNECTING FILTERS IN PARTICULAR CONFIGURATION

STAND ALONE UNIT



-  8mm silicone hose from air pump to the filter
-  22mm silicone hose from filter to the display case
-  Optional 8mm silicone hose from the case to the pump

For stand alone configuration

- Air pump output is connected to the filter input by supplied 8 mm silicone hose,
- Output of the filter is connected to the case by a 22mm supplied silicone hose.
- Optionally it is possible to connect in a closed loop, pump input can be connected back to the case.

The stand-alone system is sent with a barb brass air connector for connecting hoses to the case.

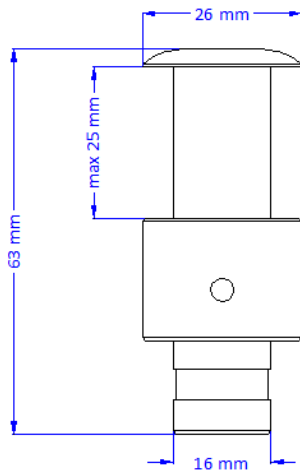

MINI ONE UNIT

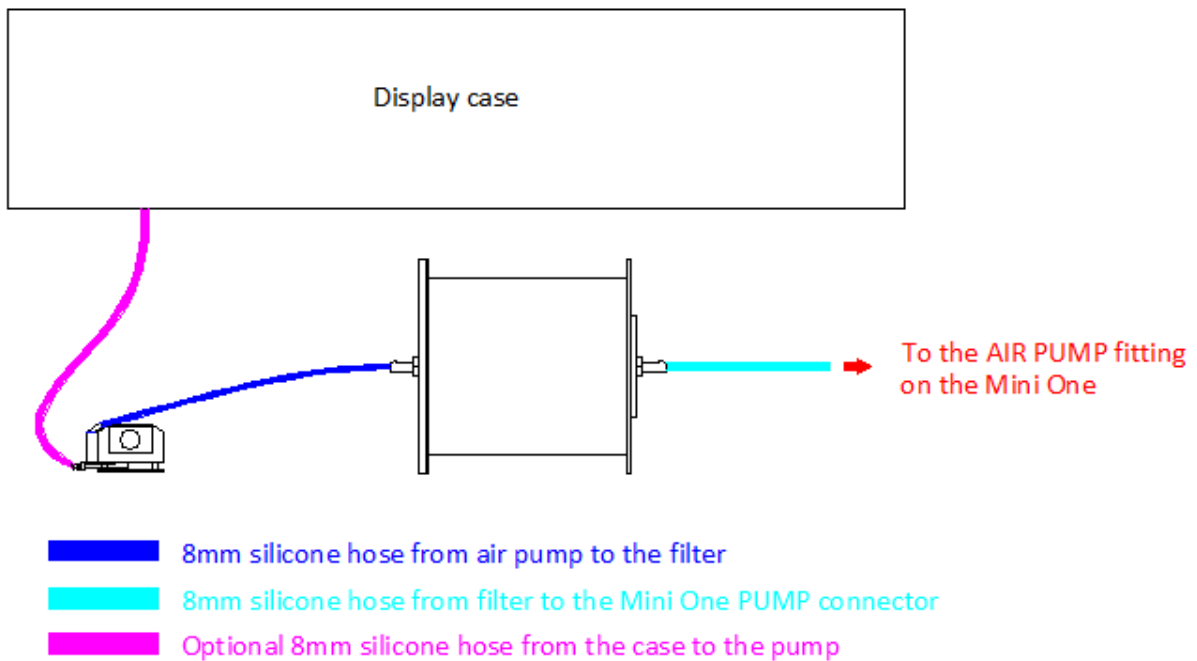

Installing inline with our Mini One

- Filter output hose is fed directly into the Minione air pump barb fitting
- All other connections are identical to the standard Mini One installation.

PMCG FILTER INSTALLATION

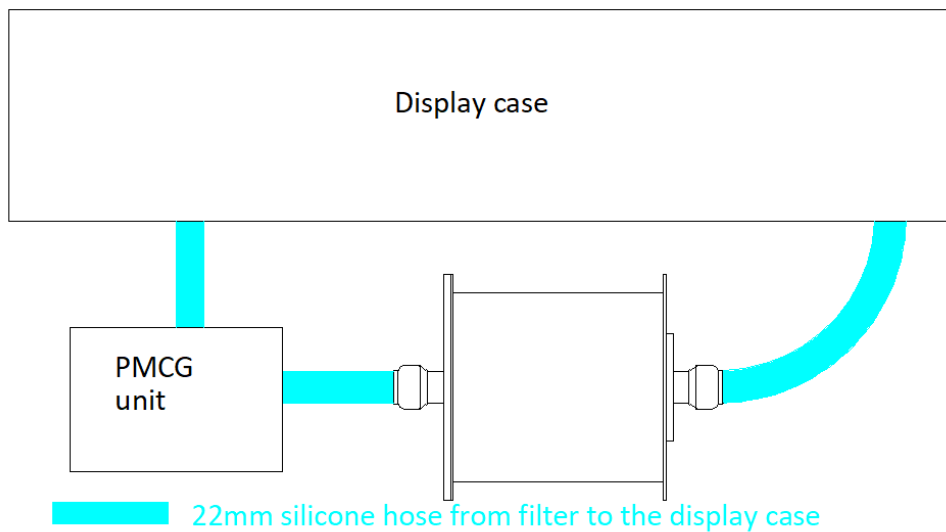

Filter on PMCG unit is installed on the hose connected PMCG output with a display case. To make sure, System will be working at full capacity, filter fan must be connected to the power by included adapter.

INSTALLATION OF DIFFERENTIAL PRESSURE SWITCH

If filter unit is ordered with pressure switch it arrives preinstalled in the factory and properly set according to the ordered configuration. Switch has build in dry relay, which can be connected to a LED, sound device or BMS.

It is also possible to connect this switch to Preservatech's monitoring system. In that case, the server will send a email if internal pressure is out of allowable range.



If a switch was not ordered, internal pressure can be measured with a client's hand held, low pressure differential manometer.

CHANGING FILTER CATRIDGES

It is very difficult to specify how often filter cartridges should be replaced since it depends on a number of factors including air quality, volume of VOC's in the air. Generally, assuming filters are installed in a relatively clean museum environment, we recommend changing filters:

- H14 filters – every 4 months
- F7 filters – every 8 months
- Carbon filter – every 6 months
- Canvas type carbon filter – every 2 months.

CE DECLARATION OF CONFORMITY

Product: Blower fan for filtration system

Description: Blower fan assisting airflow in filter system working with PMCG humidity generator.

Manufacturer: Preservatech Europe sp z o.o. sp. k. Rowna 1, 85-846 Bydgoszcz

Country of origin: Poland

The above-mentioned product complies with following regulation:

EU Low Voltage Directive 2006/95/EC

EU Electromagnetic Compatibility Directive 2004/108/EC

Harmonised Standards: EN 60335-2-98:2003 + A2:2008, EN 61000-6-3:2007 + A1: 2011, EN 61000-6-1: 2007

Signed Oct 5, 2020 in Bydgoszcz



Jan Maternicki
President